



匯統國際股份有限公司
Huey Tung International Co., Ltd.

產品規格書 Specification

[Model : HT-4114 / 2013.1.3 version]



Cara Audio Corporation

No.69, Lane 762, Dingzhong Road, Sanmin District, Kaohsiung City, Taiwan, ROC.

Tel: 886-7-310 5786 / Fax: 886-7-310 0783

E-mail: carawang@hueytung.com.tw / <http://www.hueytung.com.tw>

揚聲器製品規格書

SPEAKER SPECIFICATION

型號 Model Number: HT-4114

項目 Items		規格 Specification		
1	公称阻抗 Nominal Impedance	4Ω±15% at 350 Hz 1.0v		
2	最低共振周波数 Lowest Resonance Frequency	75 Hz±20%Hz Without a baffle		
3	实效周波数带域 Effective Frequency Range	F0~12KHz -10dB		
4	出力音压 Output Sound Pressure Level	85dB±2dB 1W/1M at (300,400,500,600)Hz AVE.		
5	入力 Input	定格入力 Rated input 20 W	最大入力 Maximum input W	
6	磁束密度 Flux Density	-----±10% GAUSS		
7	异常音试验电压 Buzz & Rattle Test	Must be normal at sine wave 6.3V, AT f0 ~ 12KHZ		
8	动作试验电压 Operation Test	Must be normal at sine wave 6.3V, AT f0 ~ 12KHZ		
9	极性 Polarity	/		
10	磁石尺寸/重量 Magnet Dimension/Weigh	Magnet: Sub Magnet:	/G	
11	连续负荷试验 Life Test	EIA-RS426B noise 20 W 8 hours	After the Test, Speaker should be meet the Outside and item 2,4	
12	耐热试验 Heat Resistance	70°C±2°C 20%-25%RH 8Hours		
13	耐湿试验 Humidity Resistance	40°C±2°C 90%-95%RH 8Hours		
14	耐寒试验 Cold Resistance	-25°C±2°C 8Hours		
15	落下试验 Drop Test	/		
16	绝缘耐压试验 Insulation Resistance	Or more 1MΩ 以上		
17	周波数特性 Frequency Response Curve	参照附图 On Other Drawing		
18	失真率 Distortion	5%		
19	各部 材质	Cone Paper	Rubber Edge+Aluminum cone	
		Voice Coil	Aluminum+SV	
		Cap	Aluminum	
20	总重量 Total Weight	1005 GR 35.5 OZ		
	Size: 4"	Approve:	Check:	Design:
	試作發行: 2009.7.15	Arthur	Tang	LIU

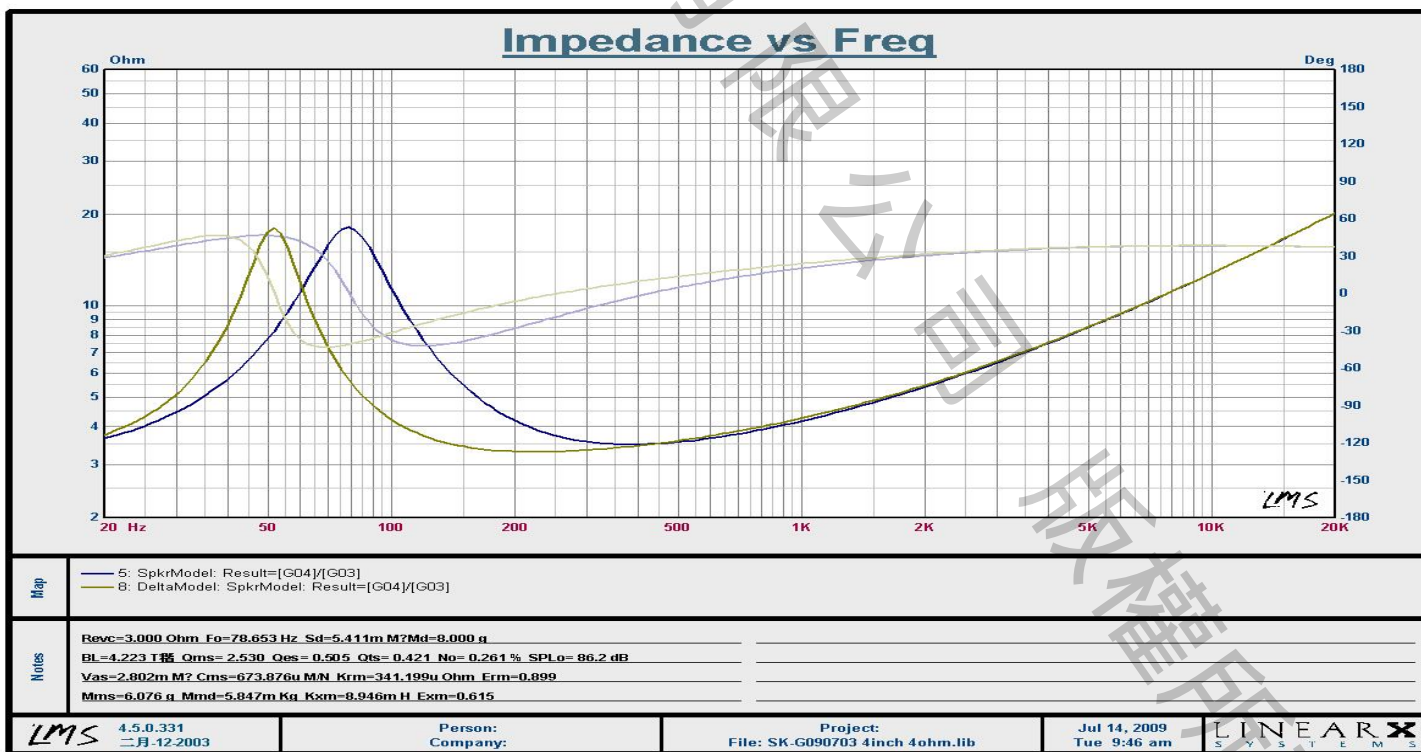
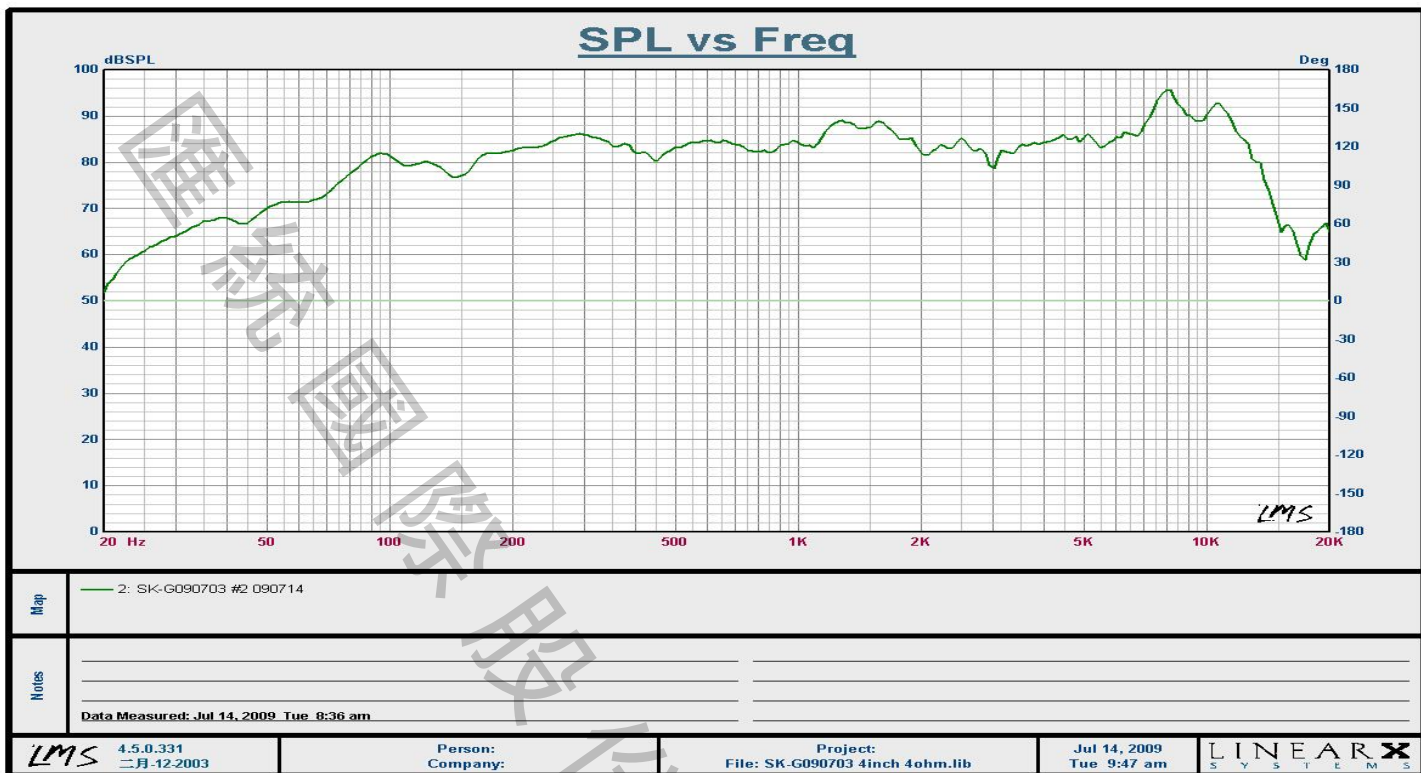

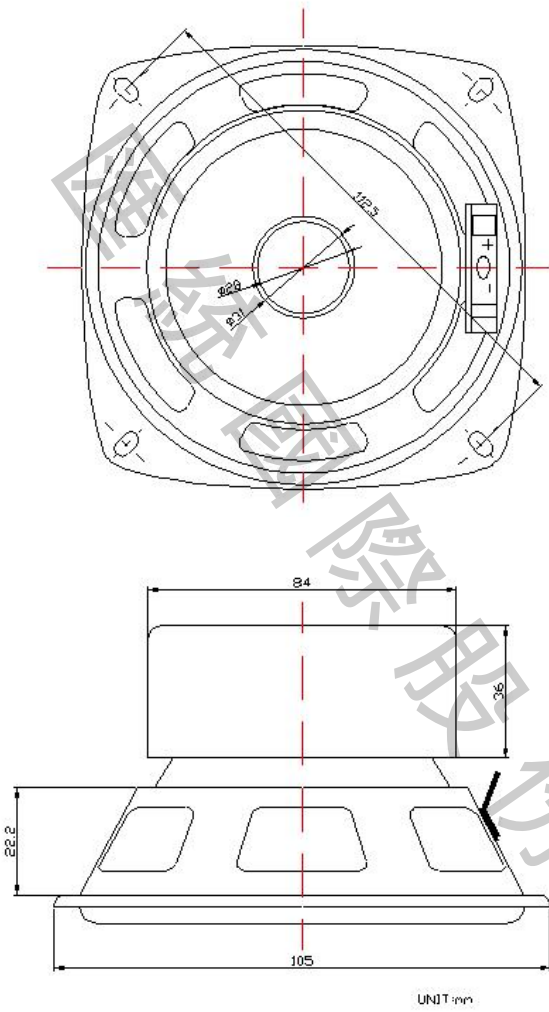

Toerance: ± 0.5

Unit:mm

版權所有